

Varenummer: 203180M16200B2T
 Beskrivelse: E+G Justerfod
 GN 31-80-M16-200-B2-T
 Note: T Uden møtrik, spændeflade i bunden

Mål

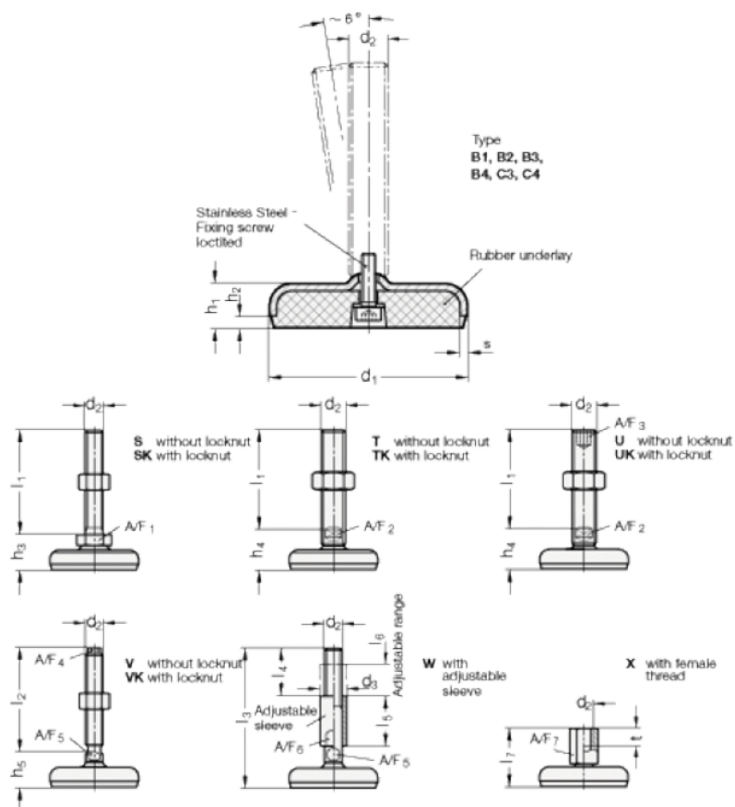

A/F2	= 12
d1	= 80
d2	= 16
h1	= 18
h2	= 5
h4 +4.0/0	= 32
l1	= 200
s	= 3